

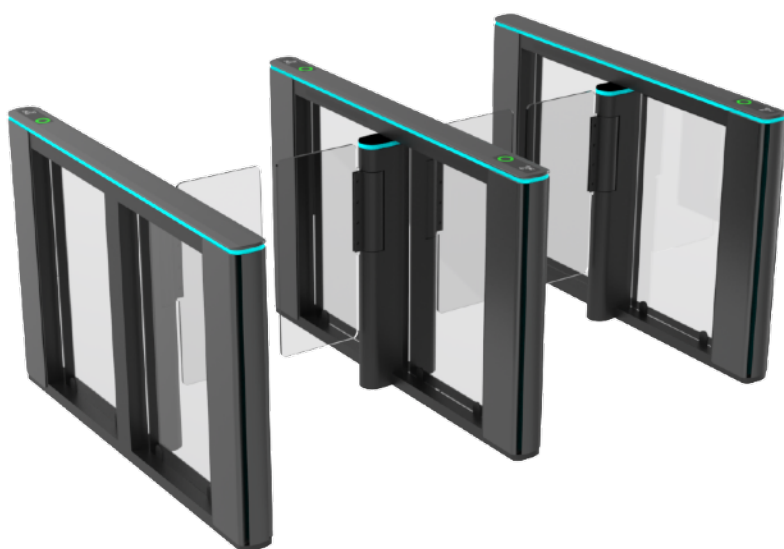

CATALOG
PRODUCT
S P E E D G A T E
C P - L 3 7 3





SPEED GATES CP-L373

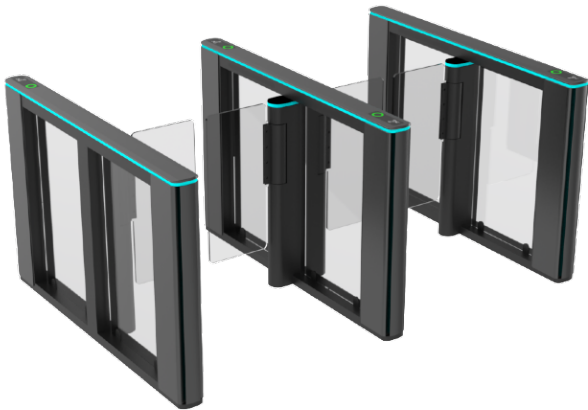

The CP-L373 speed gates is a brand-new swing gate with fast response and fast opening speed. It can reach 0.3-0.8 seconds/ time and 30-45 people/ minute. And the speed can be adjusted, which is more than twice that of ordinary swing gates, which can facilitate pedestrians to pass quickly. This is a major advantage of speed gate. It effectively solves the problem of personnel retention, and is more aesthetics in appearance design, and is more favored by customers. It is a product that combines high safety and high-quality design.

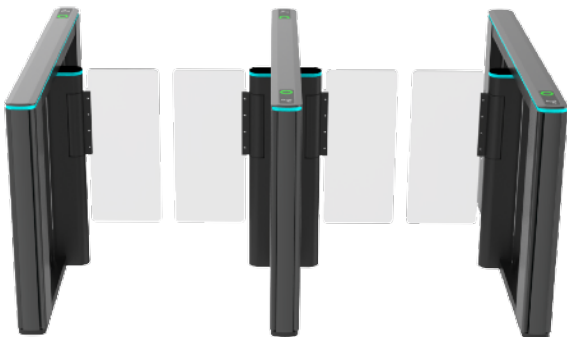

The speed gate is high compatibility, which can work with all third party access control system. It comes with 6 pairs infrared sensors to ensures the security of passage at high throughput. The reasonable design and high configuration is to ensure the gates can move quickly and accurately, stably and quietly; with low-power consumption, energy conservation and environment protection.

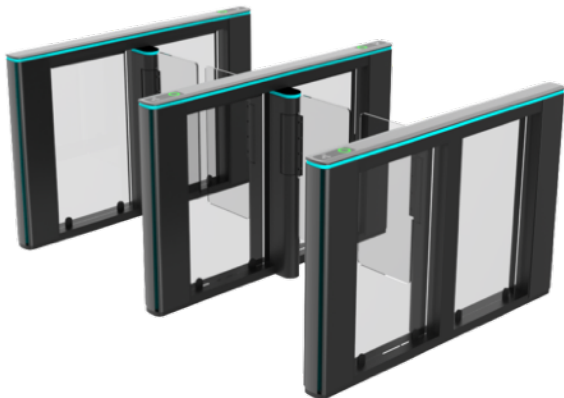

The speed gate is designed with security in mind. They have features like anti-tailgating technology, which prevents unauthorized individuals from following closely behind an authorized user to gain entry. These models also include alarms or indicators to alert security personnel to suspicious activity.

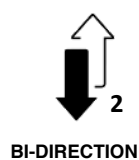



Dimension	1500*120*980mm (4.92*0.39*3.21ft) (standard)
Material	Aluminum Alloy
Swing arm Material	10mm Acrylic (standard) , Tempered glass
Passage Width	600mm (1.97ft) -1200mm (3.94ft)
Passage Height	Standard 900mm (2.92ft) - Max 1500mm (4.92ft)
Passage direction	Unidirectional/Bi-directional
Mechanism	Servo Motor
IR Sensor	6 pairs
Pass rate	40 persons/minute
Operating time	0.2 seconds
Power Supply	100V-240V, 50/60Hz
Open Signal	Passive Relay (Dry Contact)
Communication	RS232/RS485
MCBF	5,000,000 Cycles
Working Temperature	-40°C ~ 70°C
Working Environment	Indoor
Relative Humidity	95% Maximum

- **SERVO MECHANISM** The gate with servo motor, it can make a wide and high door passgate. It is more convenient for luggage, ADA, or some special application.
- **LED ALERTS** Indicate traffic direction with highly-visible green and red. The LED on the side will change based on the status of the gates.
- **LANE STATUS LED** If the access is granted, the LED will be in green. In standby, the LED is blue. If denied access, the LED flash red.
- **ALARM FUNCTION** Infrared sensor alarm function, in case of illegal intrusion and reverse intrusion.
- **EMERGENCY EXIT** The function allows free passage in the event of an emergency or power outage, automatic reset when power is restored.
- **WORKING DIRECTION** Single directional or Bi-directional is optional.
- **AUTOMATIC RESET** The swing arms will lock automatically within 5s (adjustable) if a person delay to access.
- **ANTI-COLLISION** When the gates instantaneously encounter an impulse force that is beyond the safety range, the arm will automatic reset in place. The mechanism will not be damaged at all.
- **ANTI-PASS BACK** The gate will stay in lock if someone wants to entry in the reverse direction.
- **ANTI-TRAILING** The gate will alarm if more than one person passby without permission.
- **ANTI-INTRUSION** The gate is locked automatically until a valid open signal is sent. When there is a valid signal, the gate will unlock within 0.2s (adjustable) .

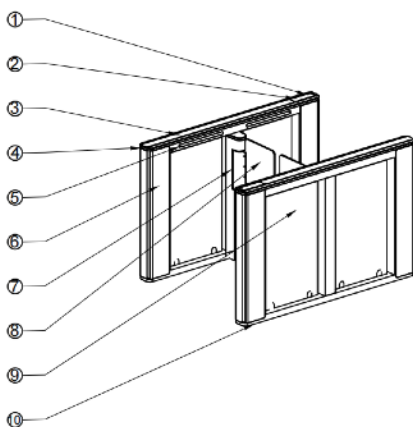

- ① Acrylic CARD Window
- ② Lane Status Indicator
- ③ Aluminum Top Lid
- ④ LED Indicator
- ⑤ IR Sensor Cover
- ⑥ Aluminum Post
- ⑦ Mechanism
- ⑧ Acrylic Barrier
- ⑨ Acrylic Side Panel
- ⑩ Position of Fixing Screw

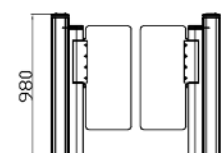
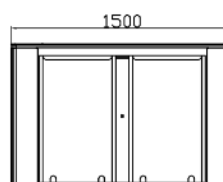
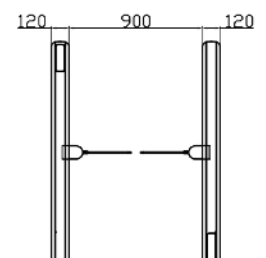



- Dimension: Can be made according to the client's site.
- Swing arm material available in glass or acrylic.
- Swing arm LED optional. The arms are more visible in the dark.
- Lights and infrared sensors can be added.
- Mounting base (for above floor wiring) and removable base (for temporary events) can be added.
- Cutouts can be customized to fit any reader. Swipe card icon can be cancelled
- LOGO can be customized.
- Customized 3D drawings are available based on the site photos.
- OEM& ODM service is available.

➤ Please check with sales for customization fees.

Our gates come with relay signals and RS485/RS232 interfaces. You can use your own access control system, or we can provide a complete access control system to you.



Remote control



RFID card



QR code/ barcode



Counter



Face recognition



Fingerprint recognition



Coin/Card collection



Button

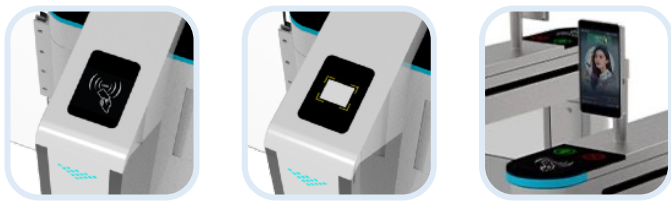

Cutouts can be customized to fit any reader.



LOGO can be customized.

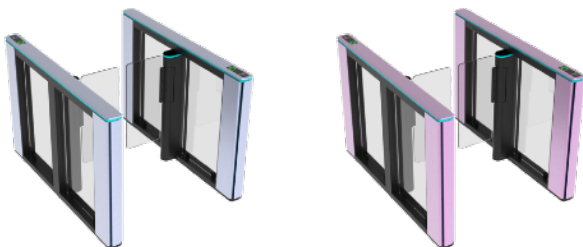

Other frame colors available, RAL or RGB required.

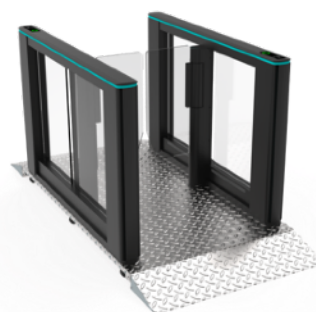

Mounting base



Powered of equipment
with Super Capacitor Backup

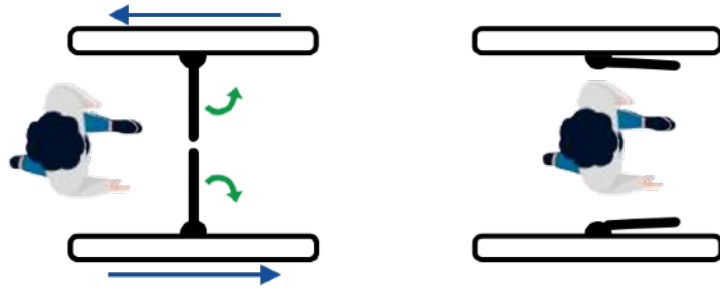

In case of a power outage, swing arms are unlocked
and open automatically.



One lane

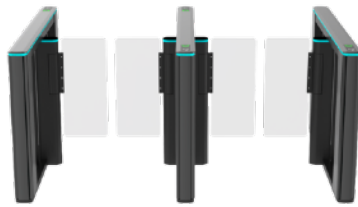

Two lanes

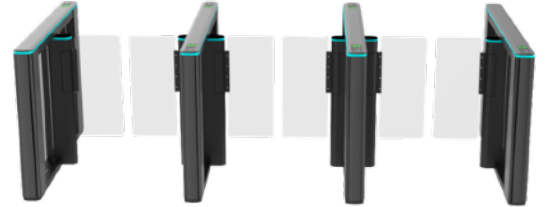

Three lanes

