

Full Height Gate Jowisz CP-PT400 YSA



CartPoland[®]
Polski Producent Kart Plastikowych

This is a classic full height turnstile with a unique structural design for the top cover, and the guardrail adopts a fully enclosed structure, making the product stronger and safer. The classic combination of Sean Black paint and stainless steel is even more innovative. The unique shaped column box integrates with the overall product, with a large internal space that can easily install any large-sized third-party access control device.



TECHNICAL SPECIFICATIONS

Dimension	1650*1500*2200mm (5.41*4.92*7.22ft) (standard)
Passage Width	710mm (2.32ft) (standard)
Passage Height	2000mm (2.13ft) (standard)
Frame Material	304 stainless steel and iron with powder coated (standard), 316 stainless steel (optional)
Mechanism	Mold Mechanism with hydraulic damper
Drive	Semi-auto operation for rotor gate with solenoid
Operation voltage	DC 24V
Power Supply	100V-240V 50/60Hz
Open Signal	Passive Relay (Dry Contact)
Communication	RS232/RS485
Working Direction	Bi-directional (standard), Unidirectional
Fire/Emergency	Free to entry and exit (standard), Entry/exit direction locked and free to exit/entry (optional)
Working Temperature	-40°C ~ 60°C
Working Environment	Indoor and Outdoor
Anti-pass back	It will lock when turn to 60 degree to prevent reservely turning
Controller	with LCD display
Relative Humidity	95% Maximum



DIMENSIONS

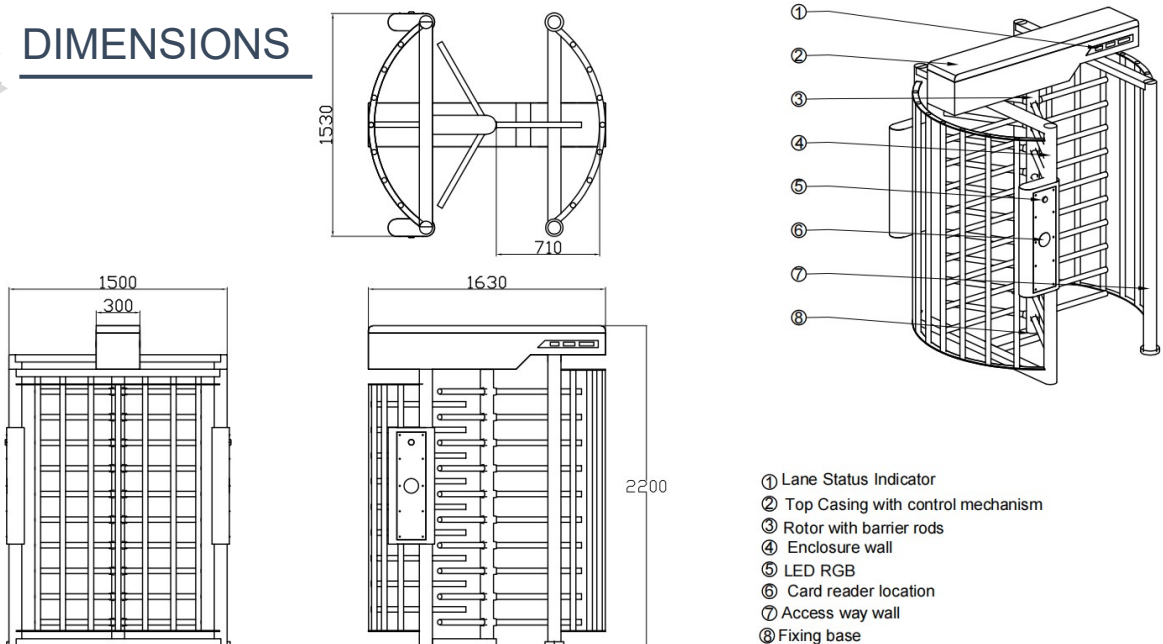

- ① Lane Status Indicator
- ② Top Casing with control mechanism
- ③ Rotor with barrier rods
- ④ Enclosure wall
- ⑤ LED RGB
- ⑥ Card reader location
- ⑦ Access way wall
- ⑧ Fixing base



PASSING SPEED



BI-DIRECTION



POWER SUPPLY



ANTI-TAILGATING



PROTECTIVE LEVEL

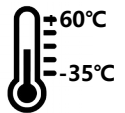

TEMPERATURE RANGE



CUSTOMIZATION

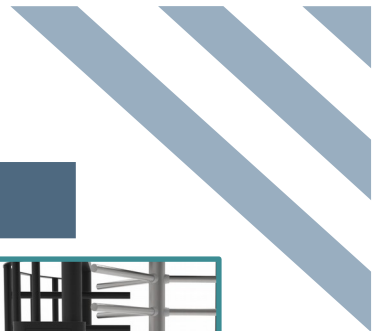

Reader pillar can be customized to fit any reader



Provide us with the dimensions of the card reader/scanner or other access control reader and we will customize the cutout according to its dimensions

LOGO can be customized

Logo can be printed on metal nameplates and attached to gates.



Chassis color can be customized

Supports paint coated or galvanized. RGB, RAL or Pantone number required.



Black



Gray



Green



Gold

Size modification

The gate can be ordered in a different size. A larger version is available with two passageways (double gate).

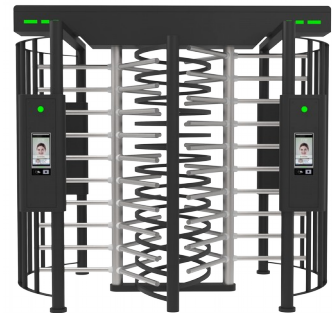

Other customizabel Options

- Gate dimensions can be customized according to the site.
- Material optional: 304 stainless steel, 316 stainless steel (wet environment), iron with powder coated and galvanized (color can be customized).
- LED colors can be customized.
- Swipe card icon can be cancelled.
- Customized 3D drawings are available based on the site photos.
- OEM&ODM service is available.



OPTIONAL ACCESSORIES

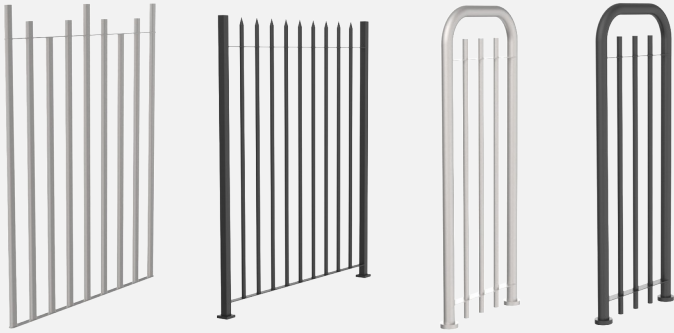

Barrier

Optional:

1. Barrier with spikes;
2. Stainless steel tube barrier;
3. 304/316 stainless steel;
4. Iron with powder coated.

Mounting Base & Canopy

Optional:

1. Mounting base (for above floor wiring) ;
2. Forklift base (for temporary events);
3. Lights can be added to the canopy.

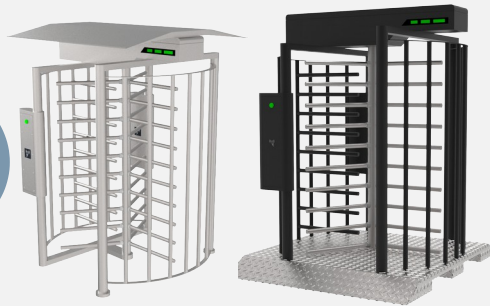

Control Panel

Buttons:

- Right/Left open
- Right/Left lock
- Right/Left free passage
- Emergency

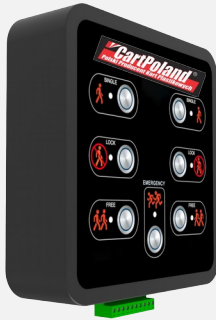

ACCESS CONTROL SYSTEM

Our gates come with relay signals and RS485/RS232 interfaces. You can use your own access control system, or we can provide a complete access control system to you.

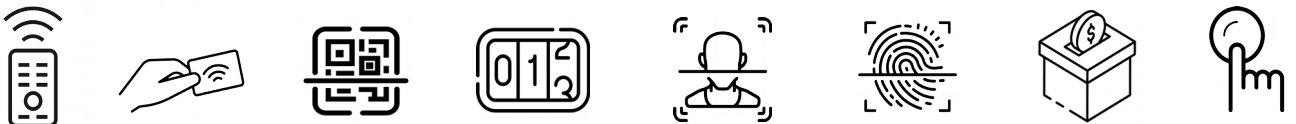



www.bramkiobrotowe.eu

office@cartpoland.pl

CartPoland Sp. z o.o.
ul. Olszowa 5, 05-300 Wólka Mińska